



CAPACITY

2200 lbs. @ 24" Load Center

INTEGRAL BATTERY / CHARGER

(2) 12V 85AH maintenance free batteries.

110V smart charger @15A

SPEED

TRAVEL

Variable from 0 mph to 3.1 mph empty
Variable from 0 mph to 2.5 mph loaded

LIFT

Up to 39 fpm empty.
Up to 20 fpm loaded

LOWERING

Up to 21 fpm empty
Up to 21 fpm loaded

TIRES / WHEELS

DRIVE

8.3" x 2.8" polyurethane

STABILITY

4" x 2" polyurethane

TANDEM LOAD

(2) 4" x 2" polyurethane

HYDRAULICS

Lift cylinder is hard chrome. Permanent magnet pump motor and chrome plated lift cylinder provides smooth lifting and lowering. Pump unit includes DC motor, solenoid, and gear pump.

DRIVE

24-Volt permanent magnet DC drive motor with rare earth neodymium magnets increases efficiency and duty cycle.

ELECTRICAL

Curtis travel control provides smooth step less travel. Quick disconnect EPD power cut off and battery discharge indicator are standard equipment.

BRAKES

Electro-magnetic disc brake.



TILLER ARM CONTROLS

Offset steering arm provides excellent line of sight for operators. Right angle stacking in aisles as narrow as 60".

Travel, lift, and lower functions are located in the ergonomic operator handle. All operator controls are accessible without having to lift the hand from the handle.

Angle grips are designed to allow easy operation with either hand. Wrap around guard, reversing switch, thumb control, and horn are standard. Low mounted tiller arm offers excellent operator comfort and minimum steering effort.

FRAME AND MAST

All steel construction welded rigid steel chassis for added durability. Adjustable forks on ITA style carriage. Forks are adjustable from 8" to 29.5" OD. Standard fork is 42" long x 4" wide x 1.5" thick

S22-62 non-telescoping mono mast with single lifting chain, adjustable mast rollers. Chrome plated lift cylinder provides smooth lift/lower operation and long life.

Three inch wide adjustable straddle legs for ease of operation in racked aisles. Four position adjustment allows for preset outrigger dimensions to fit various sized pallets. Straddle leg inside dimension (ID) can be set at 38" to 50" in 4" increments.

Fully enclosed wheel guard and flush mounted axles prevent wheel and axle damage during normal use.

S22

Walkie Straddle Stacker

NARROW AISLE STACKER, GENERAL MATERIAL HANDLING, STACKING, WORK POSITIONING IN TIGHT AREAS. STEP-UP FROM MANUAL PUSH STACKER



SERVICEABILITY

Removable one piece power head cover allows for easy maintenance.

OPTIONAL BATTERY UPGRADE

- 85AH available on model S22-62
- Hand held remote lift & lower control box with 3' coiled cord



TWO STAGE MAST

S22-96/116 telescoping high visibility mast and inner rail, clear view Plexiglas mast guard, dual lifting chains, adjustable mast rollers. Chrome plated lift cylinder provides smooth lift/lower operation.

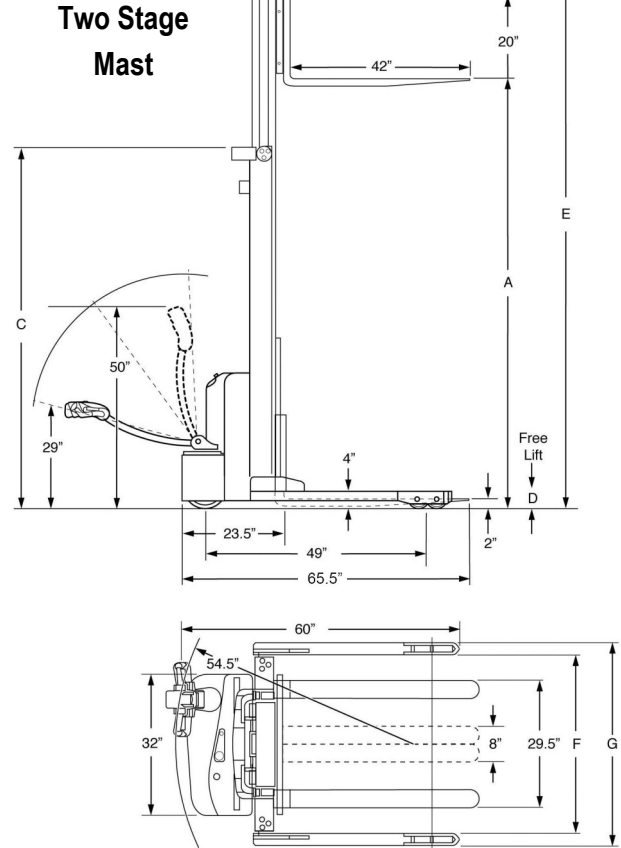
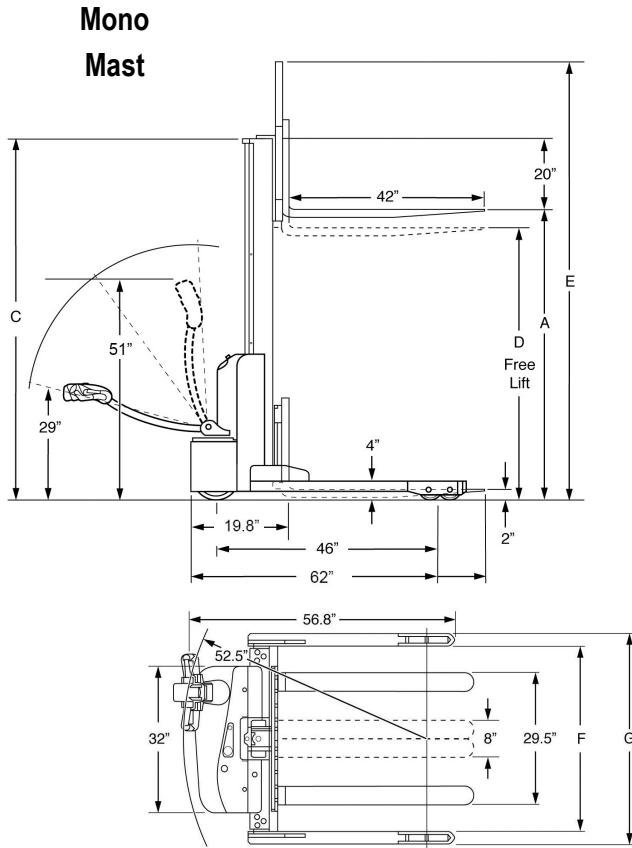

Aisle Guide

S22-62- Right Angle Stacking

Load Width	Load Length		
	36"	40"	48"
36"	57.3	57.3	57.3
40"	57.5	58.6	58.6
48"	63	63	63

For ease of use add 8" to aisle dimension listed

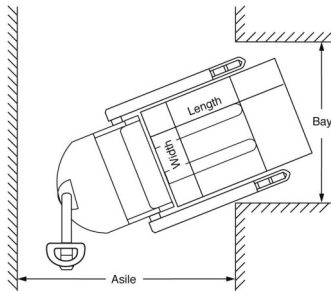

Aisle dimensions listed above assume the minimum bay width to be straddle OD plus 5" (2.5" on each either side of straddle leg). Straddle OD is the load width plus 8". Truck performance may vary due to application requirements' and changes in model design.

Add 3.9" to aisle for models S22-96 and S22-116 with two stage telescopic masts.

Model #	Mast	Lift Height	Col Height	Free Lift	Ext Height w/LBR	Adjustable Straddle Leg 4" Increments		³ Weight Complete
		A	C			ID	OD	
2200 Capacity @ 24" Load Center ITA Class II Fork Carriage								
S22-62	Mono	62	76.5	56	98.25	38 to 50	44 to 56	1200
S22-96	Two Stage	96	72.5	0	132.0	38 to 50	44 to 56	1450
S22-116	Two Stage	116	82.5	0	152.0	38 to 50	44 to 56	1500

³ Complete weight includes truck, battery and charger



CAPACITY

2200 lbs. @ 24" Load Center

INTEGRAL BATTERY / CHARGER

24-volt maintenance free batteries

110A smart charger @15A.

SPEED

Curtis transistor travel controller

TRAVEL

Variable from 0 mph to 3.1 mph empty

Variable from 0 mph to 2.5 mph loaded

LIFT

Up to 39 fpm empty.

Up to 20 fpm loaded

LOWERING

Up to 21 fpm empty

Up to 21 fpm loaded

WEIGHT

1125 lbs. with battery and charger

TIRES / WHEELS

DRIVE

8.3" x 2.8" polyurethane

STABILITY

4" x 2" polyurethane

DUAL LOAD

(2) 4" x 2" polyurethane

HYDRAULICS

Lift cylinder is hard chrome. Permanent magnet pump motor and chrome plated lift cylinder provides smooth lifting and lowering. Pump unit includes DC motor, solenoid, and gear pump.

DRIVE

24-Volt permanent magnet DC drive motor with rare earth neodymium magnets increases efficiency and duty cycle.

ELECTRICAL

Curtis travel control provides smooth step less travel. Quick disconnect EPD power cut off and battery discharge indicator are standard equipment.



BRAKES

Electro-magnetic disc brake.

TILLER ARM CONTROLS

Offset steering arm provides excellent line of sight for operators. Right angle stacking in aisles as narrow as 60".

Travel, lift, and lower functions are located in the ergonomic operator handle. All operator controls are accessible without having to lift the hand from the handle.

Angle grips are designed to allow easy operation with either hand. Wrap around guard, reversing switch, thumb control, and horn are standard. Low mounted tiller arm offers excellent operator comfort and minimum steering effort.

FRAME AND MAST

Unitized all steel construction for added durability.

S22-62R non-telescoping mono mast with single lifting chain, adjustable mast rollers. Chrome plated lift cylinder provides smooth lift/lower operation and long life.

Fully enclosed wheel guard and flush mounted axles prevent wheel and axle damage during normal use.

S22-62R

Powered Drive Forkover Stacker

FORK-OVER DESIGN OFFERS AN IDEAL WAY TO EFFICIENTLY HANDLE WIRE BASKETS, PLASTIC PALLETS, AND SKIDS. TRUCK OUTRIGGERS ARE POSITIONED UNDERNEATH THE FORKS

SERVICEABILITY

Removable one piece power head cover allows for easy maintenance.

OPTIONAL BATTERY UPGRADE

- 85AH available on model S22-62
- Hand held remote lift & lower control box with 3' coiled cord



FORKOVER RIGID CARRIAGE

Forkover style forks are fixed on a rigid carriage and nest over the straddle legs. Standard fork is 45" long x 6.75" wide x 2.25" thick.

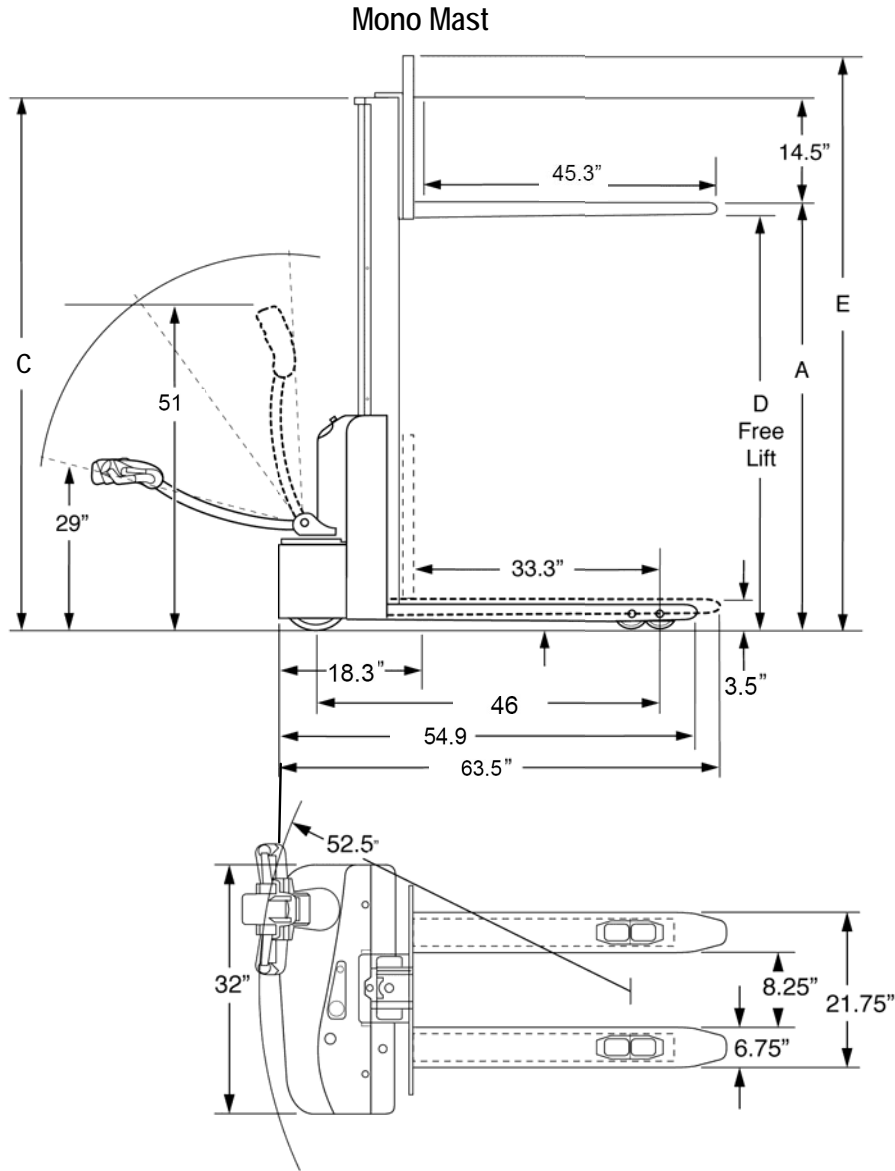

Skids, bins, and pallets without bottom boards are all loads that can be lifted by an S22 forklift

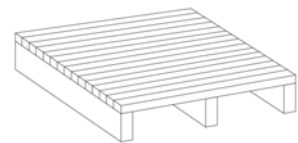

Pallet without Bottom Boards

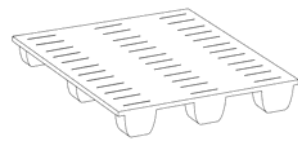

4-Way Plastic Pallet



Skid

Model #	Mast	Lift Height	Col Height	Free Lift	Ext Height w/LBR	Fixed Straddle Legs		Weight Complete ³
		A	C			ID	OD	
2200 Capacity @ 24" Load Center / Forkover - Rigid Fork Carriage								
S22-62R	Mono	62	76.5	56	77	10.0	19.9	1125

³ Complete weight includes truck, battery and charger